

# Experimental Study of an Air Lift Pump

Fawzy Sh. Abou Taleb

Mechanical Engineering Department  
Engineering College  
Northern Border University  
Arar, Saudi Arabia  
fauzy1957@yahoo.com

Jawdat A. Al-Jarrah

Mechanical Engineering Department  
Engineering College  
Northern Border University  
Arar, Saudi Arabia  
jawdatj@yahoo.com

**Abstract**—In this investigation the effect of submergence ratio and air jacket on the performance of the air lift pump has been studied. Three types of air jackets in addition to five levels of submergence ratios were used. Each air jacket has a number of drilled holes distributed uniformly at the perimeter of the inside pipe, where the total area of drilled holes was kept constant. It has been found that the water flux increases as the submergence ratio increased. Also it was found that the minimum air flux required to start discharging water from the pump decreases as the submergence ratio increases. Air jacket with a hole of 4 mm diameter, resulted the highest performance for the air lift pump.

**Keywords**—airlift pump; air-jacket; performance; submergence ratio

## I. INTRODUCTION

An air lift pump is a device used to raise the liquid or slurries from a well or vessels through a vertical pipe, partially submerged in the liquid, by means of compressed air introduced into the pipe near the lower end [1]. The theory and principle of air lift pumps were described in detail in [2]. The main advantage of the air lift pump is that there are no mechanical below-ground components, so it is essentially simple and reliable and can easily handle sandy or gritty water [3, 4]. Air lift pumps are used in a very wide range of applications, because of their simple construction, cost effective maintenance, easy performance and high reliability [5]. The two main disadvantages of the air lift pump are low water delivery height and low efficiency [6]. Numerous theoretical as well as experimental studies have been published related to the interpretation and analysis of air lift pump performance. Most of these studies were concerned with the analysis of design parameters and operational parameters on the performance of air lift pumps. In [7], authors studied design parameters such as riser diameter and air injector design. The operational parameters; such as submergence ratio, air injection conditions, and nature of solid phase, which required to be lifted were studied in [8]. In [9], authors studied the performance of the air lift pump for various values of submergence ratio. In [10], authors showed that the capacity and efficiency of the air lift pump are function of air mass flow rate, submergence ratio and the riser pipe length. The best efficiency ranges are found to be in slug and slug-churn flow regimes [11].

In this investigation the air lift pump performance was studied with different air jackets which are used to introduce the air to the pump.

## II. EXPERIMENTAL WORK

The air lift pump is consisted of two main units, the first is the main body of the pump and the second is the air supply unit. Figure 1 shows the main body of the air lift pump set-up which was used in this experiment. The body of the air lift pump consists mainly from a vertical pipe divided into static lift (submergence length) and static head (riser). In addition two tanks were used, one as a reservoir tank and the other as a collecting tank. Compressed air with high pressure is injected through an air jacket. Compressed air is supplied into the pump from the compressor tank through an air-supply line. The airflow rate is measured using a calibrated sharp-edged orifice meter connected to U-tube mercury manometer. The water flow rate is calculated by weighed the collected water for a specific time period. The length of suction pipe was chosen to prevent the injected air to bubble back into the water reservoir.

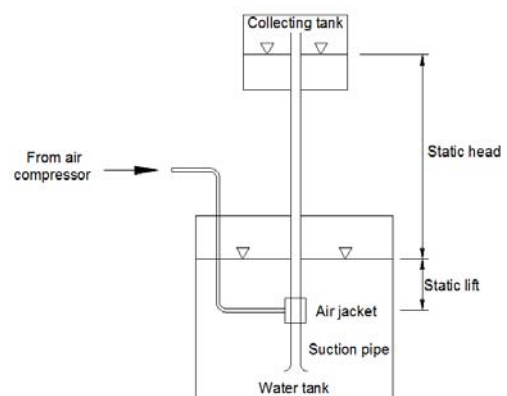

Fig. 1. Schematic diagram of the main body of the airlift pump.

The static lift (submergence length) is measured as the height of the free surface level water from the air injection system. Submergence ratio is calculated as the submergence length divided by the length of the total length of the pipe (the sum of static lift and static head). The static head is the height

where the water is to be raised. The hydrostatic head in the water reservoir is also controlled by water control valve, so that submergence ratio is kept constant. Five levels of submergence ratios were used in this investigation as 18, 25.8, 33.6, 41.4 and 49.2% .

The air injection system is an air jacket type placed on the vertical pipe axis. The air jacket consists from a perforated internal pipe of 5.08 cm inside diameter surrounded by a large iron tube of 15.24 cm inside diameter. Three types of air jackets were used in this analysis by varying the size of drilled holes, where the total air injection area is kept constant. Figure 2 illustrates the used air-jacket in this analysis. Each air jacket has a number of holes drilled uniformly through the perimeter of the pipe distributed into rows and columns. Table I shows the hole size and the numbers of rows and columns of each air jackets that used in this analysis. The two pipes have a height of 20 cm and are flanged together forming the air injection system. According to this design, the air is uniformly distributed around the lifting pipe so that the radial momentum of the air is balanced with each other.

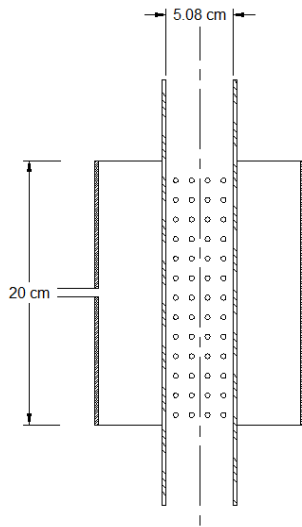

Fig. 2. Schematic diagram of air injection jacket

TABLE I. TYPES OF AIR-IACKETS.

Air-jacket	Hole size, mm	Number of rows	Number of columns
A1	2	12	8
A2	4	6	4
A3	6	5	2

III. RESULTS AND DISCUSSION

The performance of the air lift pump is affected by many factors such as submergence ratio, air flow rate and the section area of riser pipe as suggested in [2]. In this investigation five levels of submergence ratio were used, 18, 25.8, 33.6, 41.4 and 49.2%. However, the terms of water flux  $J_w$ , and air flux,  $J_a$ , are used instead of water flow rate and air flow rate respectively. The flux of water and air are calculated by dividing the measured volumetric flow rate of water and air by the cross sectional area of the static head pipe. Figure 3 shows

the variations of the water flux,  $J_w$ , with the variation of air flux,  $J_a$ , at different submergence ratios.

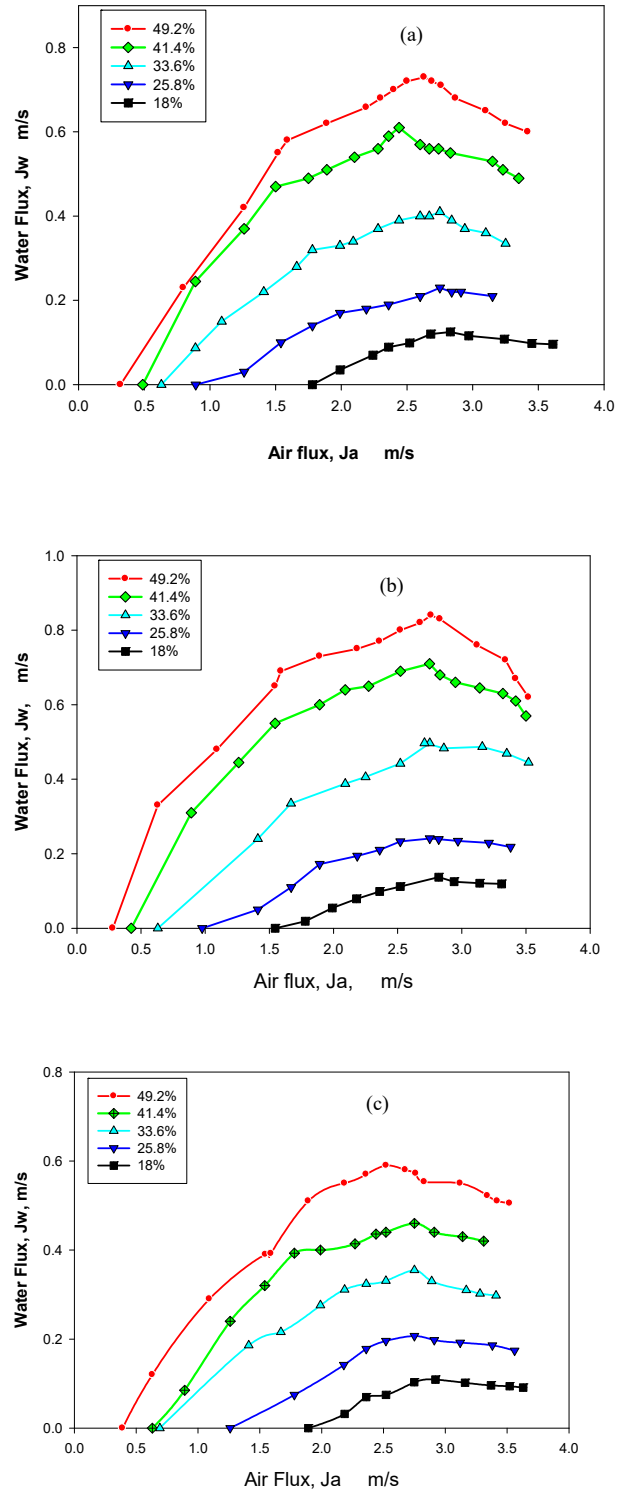

Fig. 3. Variation of water flux,  $J_w$ , with air flux,  $J_a$ , at different submergence ratio for air jackets (a) A1, (b) A2 and (c) A3

Three types of air jackets A1, A2, and A3 were used in these experiments. It has been shown that the water flux is larger at submergence ratio of 49.2% than those of 41.4, 33.6, 25.8 and 18% for the same amount of air flux, where the same trend was obtained in [12].

Figure 4 reveals the effect of air jacket types on the water flux. It has been found that the water flux is more in case of air jacket, A2, than that of other types of air jackets. However, the water flux increases as the air flux increases as shown in Figures 3 and 4. But at higher air flux excess of air is introduced to the air jacket, which leads to decrease on the water flux. Figure 3 shows that the amount of air flux that leads to decrease on the water flux increases as the submergence ratio increases. The scenario of air lift pump

working, at low air flux, if small bubbles injected into the draft tube, the bubbles will remain distributed over the cross section of the tube and sustain flow regime known as bubble flow. While increasing the rate of the air flux, the small air bubbles begins to coalesce into larger bubble which in essence separate the water column into slug flow regime. The transition between these flow regimes is characterized as the bubbly-slug flow regime where small bubbles are found suspended within the liquid slugs between the larger air slugs [13]. Increasing the size of air bubbles by using a larger hole size as in air jackets, A2, reduces the required air flux to has bubbly slug flow regime. However, it was reported that maximum water flux happened when the flow changed from bubbly-slug flow to slug-churn flow [11].

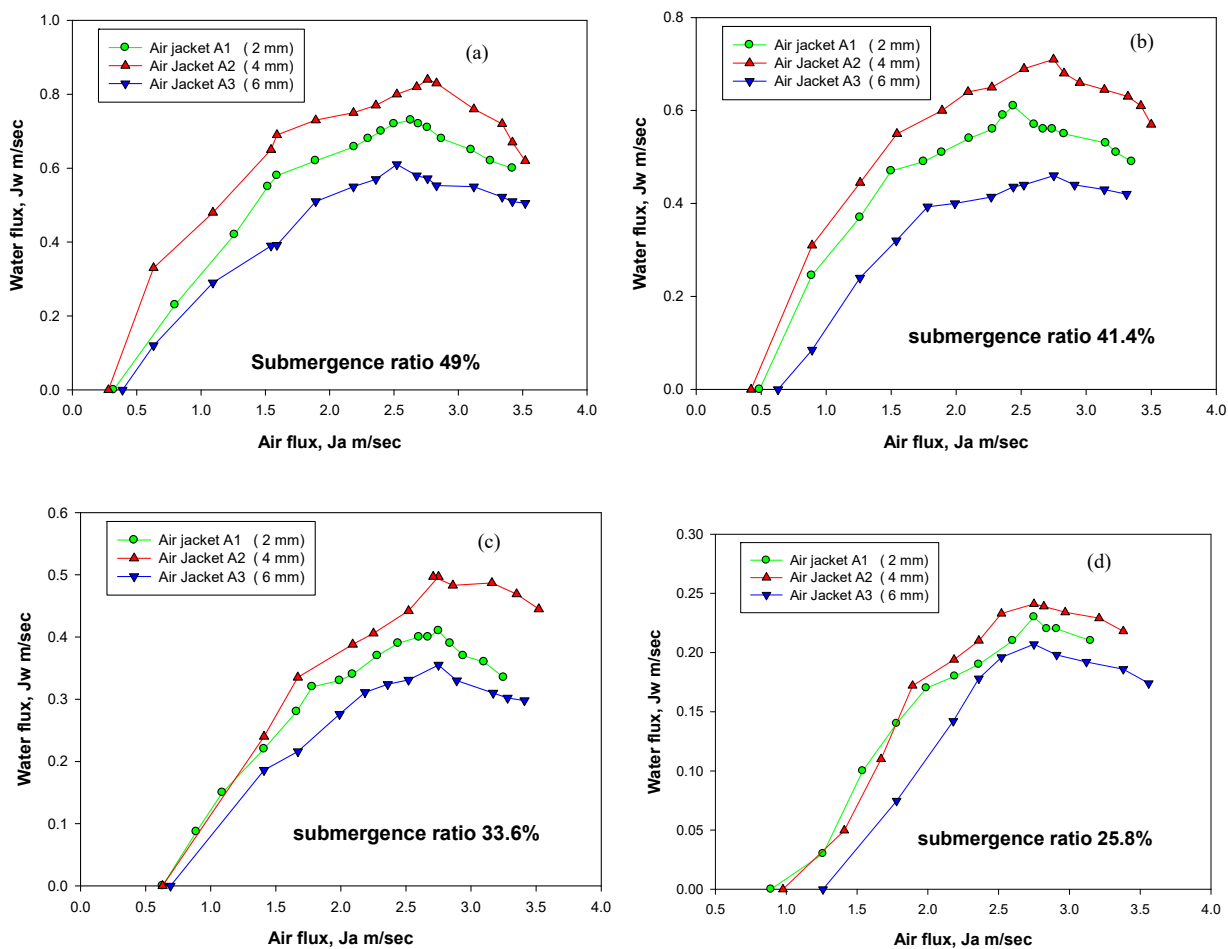

Fig. 4. The effect of water jacket types on water flux at different submergence ratio of (a) 49%, (b) 41.4%, (c) 33.6% and (d) 25.8%

Figure 5 shows the effect of drilled hole size of air jackets on water flux at different submergence ratio. The method of air injection has affected the airlift pump performance, different methods used before such as air stone, injector plates [14]. In this study the surface area of the air bubbles is changed by using three sizes of drilled holes 2, 4 and 6 mm for A1, A2 and A3 air jackets respectively. The total area of drilled holes was kept constant by varying the number of holes in each air jacket. It has been noticed that the air jacket, A2, has the best water flux for all submergence ratios, as shown in Figure 5. At low submergence ratio of 33.6 and 25.8%, there is no difference in water flux resulted from A1 and A2 and its more clear at submergence ratio of 25.8% as shown in Figure 3d, especially at low air flux. For a given depth of submergence, an airlift requires a minimum air inflow rate to start pumping water as noted in [15]. Figure 6 shows the minimum air flux needed to start pumping of water, for each air jacket

with variation of submergence ratio. It has been shown that for higher submergence ratio less air flux is needed to start pumping. However, air jacket A2, needs minimum air flux especially at higher submergence ratio 49% compared by other air jackets A1 and A3.

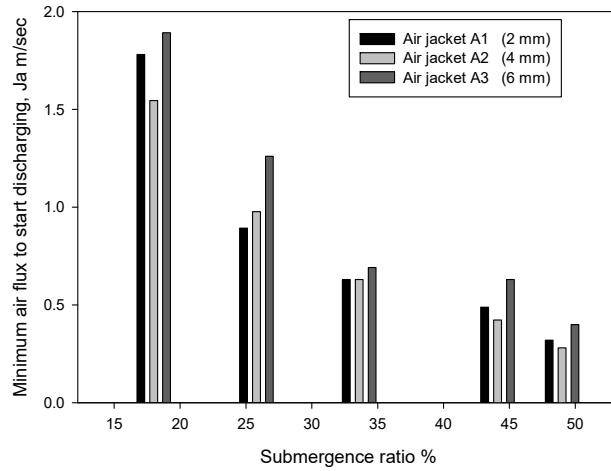

Fig. 5. Variation of minimum air flux to start discharging with submergence ratio

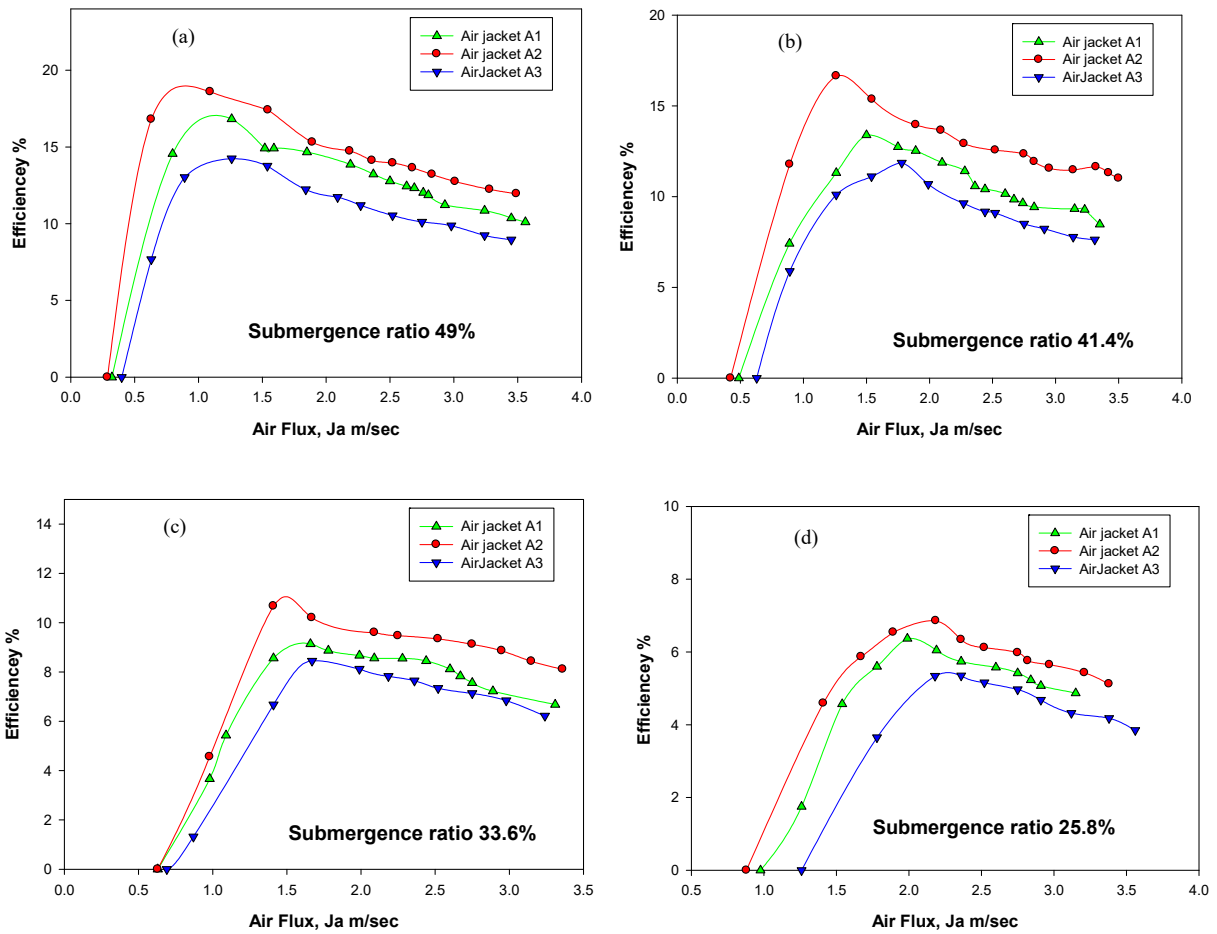

Fig. 6. Variation of efficiency with air flux for submergence ratio of (a) 49%. (b) 41.4%, (c) 33.6% and (d) 25.8%

The efficiency of the air-lift pump is calculated based on the definition in [16]. The efficiency is defined as the ratio of power required to lift the solid or the liquid phase to the point of discharge to the power required to compress the air isothermally through the compressor from atmospheric pressure to the air injection pressure. Figure 7 shows the variation of the efficiency with air flux for three types of air jacket at different submergence ratios. The efficiency increased as the air flux increased to a certain level then for further increases of air flux the air-lift pump efficiency reduced. Air jacket A2 has the best efficiency as compared to air jackets A1 and A3 at all submergence ratios. Also, the efficiency increased as the submergence ratio increased as shown in Figure 7. Air jackets A1 and A3 have the same efficiency trend with the variation of submergence ratio. The ratio of air flux to water flux at the maximum efficiency was calculated using Fig.5. It has been found that the air to water ratio at higher submergence ratio of 49.2% and 41.4, to be about 2. This agreed by which obtained in [17, 18] where it was stated that a gas to liquid ratio between 1 and 2 is ideal for optimum performance of an air lift for low head applications.

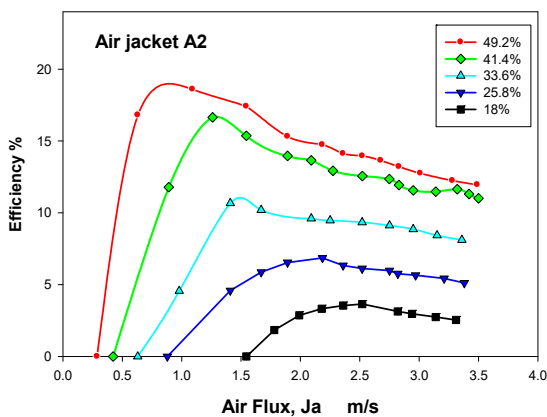

Fig. 7. Variation of efficiency with air flux at different submergence ratios.

#### IV. CONCLUSIONS

The following concluded remarks can be deduced from the present study:

- 1) The maximum efficiency does not occur at the maximum water flux.
- 2) As the submergence ratio increases, the maximum water flux and maximum efficiency of the pump increase for the same air flux.
- 3) For the same air flux, Air jacket, A2, has the maximum water flux and efficiency.
- 4) The minimum of air flux needed, to start water discharge from the pump, decreases as the submergence ratio increases.

#### ACKNOWLEDGMENT

The authors wish to acknowledge the approval and support of this research study by Grant 435-20 from Deanship of Scientific Research in Northern Border University, Arar, KSA.

#### REFERENCES

- [1] N. N. Clark, R. J. Dabolt, "A general equation of air lift pump operating in slug flow", *AIChE. J.*, Vol. 32, pp. 56-64, 1986
- [2] D. J. Nicklin "The airlift pump: theory and optimization", *Trans. Inst. Chem. Eng.*, Vol. 41, pp. 29-39, 1963
- [3] J. M. Delhaye, "Two-phase pipe flow", *Int. Chem. Eng.*, Vol. 23, pp. 385-410, 1983
- [4] D. J. Ryley, G. J. Parker, "Flowing geothermal wells: Cerro Priet wells M.91 and Krafla well KJ-9.1: Computer analysis compared with experimental data", *Int. Conf. on Geothermal Energy, Florence Italy*, pp. 187-196, 1982
- [5] A. Mahrous, "Experimental study of airlift pump performance with S-shape riser tube bend", *Int. J. of Eng. and Manuf.*, Vol. 1, pp. 1-12, 2013
- [6] B. Barrut, J. P. Blancheton, J. Y. Champagne, A. Grasmick, "Mass transfer efficiency of a vacuum airlift-application to water cycling in aquaculture systems", *Aquaculture Eng.*, Vol. 46, pp. 18-26, 2012
- [7] G. K. Awari, P. M. Ardhapurkar, D. G. Wakde, L. B. Bhuyar, "Performance analysis of air-lift pump design", *Proc. IMECH E Part C: J. Mech. Eng. Sci.*, Vol. 218, pp. 1155-1161, 2004
- [8] S. Z. Kassab, H. A. Kandil, H. A. Warda, W. H. Ahmed, "Experimental and analytical investigations of airlift pumps operating in three-phase flow", *Chem. Eng. J.*, Vol. 131, pp. 273-281, 2007
- [9] A. H. Stenning, C. B. Martine, "An Analytical and experimental study of airlift pump performance", *ASME J. Eng. for Pow.*, Vol. 90, pp. 106-112, 1968
- [10] N. F. Al-Saquer, M. Al-Shibani, "Experimental study of airlift pumps characteristics", *Int. J. of Eng. Res. and Appl.*, Vol. 4, pp. 883-895, 2014
- [11] S. Z. Kassab, H. A. Kandil, H. A. Warda, W. H. Ahmed, "Air-lift pump characteristics under two phase flow conditions", *Int. J. of Heat and Flow*, Vol. 30, pp. 88-98, 2009
- [12] V. C. Samaras, D. P. Margaris, "Two-phase flow regime maps for air-lift pump vertical upward gas-liquid flow-part II", *International Journal of Multiphase Flow*, Vol. 31, No. 6, pp.757-766, 2005
- [13] D. J. Reinemann, M. B. Timmons, "Predicting oxygen transfer and total dissolved gas pressure in airlift pumping", *Aquacultural Engineering*, Vol. 8, pp. 29-46, 1989
- [14] M. F. Khalil, K. A. Elshorbagy, S. Z. Kassab, R. I. Fahmy, "Effect of air injection method on the performance of an airlift pump", *Int. J. Heat and Fluid Flow*, Vol. 20, pp. 598-604, 1999
- [15] G. L. Morrison, T. I. Zeineddine, M. Henriksen, G. B. Tatterson, "Experimental analysis of the mechanics of reverse circulation air lift pump", *Industrial Engineering and Chemical Research*, Vol. 26, pp. 387-391, 1987
- [16] D. J. Nicklin, "Two phase bubble flow", *Chemical Eng. Sci.*, Vol. 17, pp. 693-702, 1962
- [17] I. Todoroki, Y. Sato, T. Honda, "Performance of airlift pump", *Bulletin of the Japan Society of Mechanical Engineers*, Vol. 16, pp. 733-741, 1973
- [18] C. J. Loyless, A feasibility study of using airlift pumps for aeration, degasification, and water movement in recirculating aquaculture system, Thesis, Louisiana State University, 1995